



■ 特性

- 符合铁道标准BS EN/EN50155 和 BS EN/EN45545-2
- 超薄宽度 32mm
- 2:1 宽范围输入
- -40~+70°C 宽范围工作温度
- 150% 峰值负载能力
- 直流输出电压可调
- 可自然冷风散热
- 安装导轨: TS-35/7.5 或 15
- 保护种类: 短路 / 过载 / 过压 / 输入反极性 / 输入欠压保护
- 4KVdc 输入 / 输出隔离 (增强隔离)
- 3 年保固

■ 应用

- 公共汽车、电车、地铁或铁路系统
- 工业控制系统
- 半导体制造设备
- 工厂自动化
- 机电设备
- 无线网络
- 电信和数据通信系统

■ 全球交易品项识别码

MW搜寻: <http://www.meanwell.com.cn/serviceGTIN.aspx>

■ 描述

DDR-120 系列 是一款120W导轨型DC-DC转换器, 其主要特点为导轨型安装便捷,宽度仅为32mm的超薄设计, 2:1的超宽范围输入电压, 无风扇设计,-40~+70°C 的宽范围工作温度, 4KVdc的输入/输出隔离, 150%的峰值负载, 输出电压可调节以及完整的保护功能。

DDR-120系列机型有多种输入选择: 9~18V / 16.8~33.6V / 33.6~67.2V / 67.2~154V 和多种输出选择: 12V / 24V / 48V,适用于工业及铁路控制、安全控制、通讯系统等领域。此系列还适用于直流降压/升压调节器, 提高了系统绝缘等级和电缆沿线压降补偿.....等。

■ 型号编码

DDR-120A-24

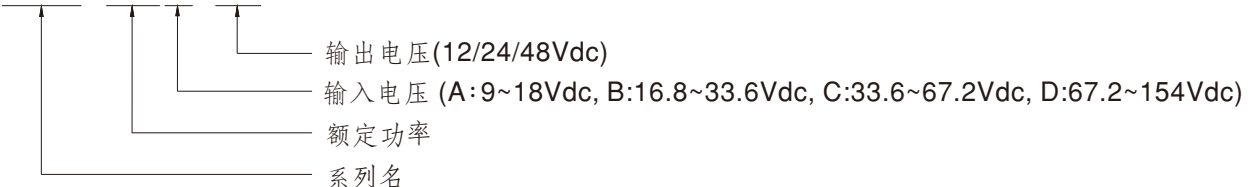



电气规格

型号	DDR-120A-12	DDR-120A-24	DDR-120A-48	DDR-120B-12	DDR-120B-24	DDR-120B-48	
输出	直流电压	12V	24V	48V	12V	24V	48V
	额定电流	8.3A	4.2A	2.1A	10A	5A	2.5A
	电流范围	0 ~ 8.3A	0 ~ 4.2A	0 ~ 2.1A	0 ~ 10A	0 ~ 5A	0 ~ 2.5A
	额定功率	99.6W	100.8W	100.8W	120W	120W	120W
	峰值电流	12.45A	6.3A	3.15A	15A	7.5A	3.75A
	峰值功率 备注5	150W (3sec.)			180W (3sec.)		
	纹波与噪声(最大)备注2	50mVp-p	50mVp-p	50mVp-p	50mVp-p	50mVp-p	50mVp-p
	电压调整范围	9 ~ 14V	24 ~ 28V	48 ~ 56V	9 ~ 14V	24 ~ 28V	48 ~ 56V
	电压精度 备注3	±1.0%	±1.0%	±1.0%	±1.0%	±1.0%	±1.0%
	线性调整率	±0.5%	±0.5%	±0.5%	±0.5%	±0.5%	±0.5%
	负载调整率	±1.0%	±1.0%	±1.0%	±1.0%	±1.0%	±1.0%
	启动、上升时间	500ms, 60ms @12Vdc			500ms, 60ms @24Vdc		
	保持时间(Typ.)	请参阅第7页保持时间(负载减额曲线)					
输入	电压范围 备注4	9 ~ 18Vdc	9 ~ 18Vdc	9 ~ 18Vdc	16.8 ~ 33.6Vdc	16.8 ~ 33.6Vdc	16.8 ~ 33.6Vdc
	效率(Typ.)	88.5%	88.5%	88.5%	89%	89.5%	91%
	直流电流(Typ.)	11.2A @12Vdc			5.6A @24Vdc		
	浪涌电流(Typ.)	5A @12Vdc			5A @24Vdc		
	电压中断	EN50155:2007-3ms(满载时)			EN50155:2007-符合S1等级6ms(满载时), 符合S2等级(10ms)(70%负载)		
保护	过负载	150%额定输出功率时, 正常工作超过3秒后关闭输出电压, 进入定电流保护模式, 恒流点为(105~135%), 并可自动恢复					
	过电压	14.4 ~ 16.8V	28.8 ~ 33.6V	57.6 ~ 67.2V	14.4 ~ 16.8V	28.8 ~ 33.6V	57.6 ~ 67.2V
	反极性	保护模式: 关断输出电压, 重启后恢复					
	欠压锁定	12Vin (A-type): 电源 ON ≥ 9V, OFF ≤ 8.5V			24Vin (B-type): 电源 ON ≥ 16.8V, OFF ≤ 16.5V		
	工作温度	-40 ~ +70°C (请参考"降额曲线")					
环境	工作湿度	5 ~ 95% RH, 无冷凝					
	储存温度、湿度	-40 ~ +85°C, 5 ~ 95% RH, 无冷凝					
	温度系数	±0.03%/°C (0 ~ 55°C)					
	耐振动	组件: 10 ~ 500Hz, 5G 10分钟/周期, X, Y, Z 各60分钟; 安装: 符合 IEC61373					
	操作海拔高度	5000米					
安规和电磁兼容(备注6)	安全规范	IEC 62368-1, UL 62368-1, EAC TP TC 004, AS/NZS 62368.1 认证通过; 设计参考 UL508					
	耐压	I/P-O/P: 4KVdc I/P-FG: 2.5KVdc O/P-FG: 2.5KVdc					
	绝缘阻抗	I/P-O/P, I/P-FG, O/P-FG: >100M Ohms / 500Vdc / 25°C / 70% RH					
	电磁兼容发射	Parameter	Standard			Test Level / Note	
		Conducted	BS EN/EN55032			Class B	
		Radiated	BS EN/EN55032			Class B	
		Voltage Flicker	BS EN/EN61000-3-3			-----	
		Harmonic Current	-----			-----	
	电磁兼容抗扰度	BS EN/EN55035, BS EN/EN61000-6-2(BS EN/EN50082-2)					
		Parameter	Standard			Test Level / Note	
		ESD	BS EN/EN61000-4-2			Level 3, 8KV air; Level 3, 6KV contact; criteria A	
		Radiated	BS EN/EN61000-4-3			Level 3, 10V/m; criteria A	
		EFT / Burst	BS EN/EN61000-4-4			Level 3, 2KV; criteria A	
		Surge	BS EN/EN61000-4-5			Level 3, 1KV/Line-Line; Level 3, 2KV/Line-Line-FG; criteria A	
		Conducted	BS EN/EN61000-4-6			Level 3, 10V; criteria A	
Magnetic Field		BS EN/EN61000-4-8			Level 4, 30A/m; criteria A		
铁道标准	符合BS EN/EN45545-2 防火; 满足BS EN/EN50155 / IEC60571 包含 IEC61373 冲击和震动, BS EN/EN50121-3-2 电磁兼容(除了 9~18Vin)						
其它	MTBF	1769.5K hrs min. Telcordia SR-332 (Bellcore); 214.5K hrs min. MIL-HDBK-217F (25°C)					
	尺寸	32*125.2*102mm (W*H*D)					
	包装	510g; 28pcs/15.3Kg/1.22CUFT					
备注	1. 如未特别说明, 所有规格参数均在输入为A:12Vdc, B:24Vdc、额定负载、25°C环境温度下进行量测。						
	2. 纹波和噪声测量方法: 使用一条12"双绞线, 同时终端要并联0.1uf和47uf的电容, 在20MHZ带宽下进行量测。						
	3. 精度: 包含设定误差、线性调整率和负载调整率。						
	4. 低输入电压情况下需降额输出, 具体请参考降额曲线图。						
	5. 最长3秒, 请参考峰值负载曲线。						
	6. 电源应视为一个独立的元件, 需结合终端设备进行电磁兼容相关确认。有关EMC测试操作指导, 请参阅"电源供应器EMI测试声明书"。(在明纬网站 http://www.meanwell.cc)						
	7. 当海拔高度超过2000米(6500英尺)时, 无风扇机型环境温度依每3.5°C/1000m比例下降, 有风扇机型环境温度依每5°C/1000m比例下降。 ※ 产品免责声明: 详情请参阅 http://www.meanwell.cc/serviceDisclaimer.aspx						

电气规格

型号		DDR-120C-12	DDR-120C-24	DDR-120C-48	DDR-120D-12	DDR-120D-24	DDR-120D-48	
输出	直流电压	12V	24V	48V	12V	24V	48V	
	额定电流	10A	5A	2.5A	10A	5A	2.5A	
	电流范围	0 ~ 10A	0 ~ 5A	0 ~ 2.5A	0 ~ 10A	0 ~ 5A	0 ~ 2.5A	
	额定功率	120W	120W	120W	120W	120W	120W	
	峰值电流	15A	7.5A	3.75A	15A	7.5A	3.75A	
	峰值功率 备注5	180W (3sec.)						
	纹波与噪声 (最大) 备注2	50mVp-p	50mVp-p	50mVp-p	50mVp-p	50mVp-p	50mVp-p	
	电压调整范围	9 ~ 14V	24 ~ 28V	48 ~ 56V	9 ~ 14V	24 ~ 28V	48 ~ 56V	
	电压精度 备注3	±1.0%	±1.0%	±1.0%	±1.0%	±1.0%	±1.0%	
	线性调整率	±0.5%	±0.5%	±0.5%	±0.5%	±0.5%	±0.5%	
	负载调整率	±1.0%	±1.0%	±1.0%	±1.0%	±1.0%	±1.0%	
	启动、上升时间	500ms, 60ms @48Vdc			500ms, 60ms @110Vdc			
	保持时间(Typ.)	请参阅第7页保持时间 (负载减额曲线)						
输入	电压范围 备注4	33.6 ~ 67.2Vdc	33.6 ~ 67.2Vdc	33.6 ~ 67.2Vdc	67.2 ~ 154Vdc	67.2 ~ 154Vdc	67.2 ~ 154Vdc	
	效率(Typ.)	89.5%	91%	92%	89.5%	91%	91.5%	
	直流电流(Typ.)	2.8A @48Vdc			1.3A @110Vdc			
	浪涌电流(Typ.)	5A @48Vdc			5A @110Vdc			
	电压中断	EN50155:2007-符合S1等级6ms(满载时),符合S2等级(10ms)(60%负载) EN50155:2017-符合S1等级			EN50155:2007-符合S2等级(10ms)(满载时) EN50155:2017-符合S1等级			
保护	过负载	150%额定输出功率时,正常工作超过3秒后关闭输出电压,进入定电流保护模式,恒流点为(105~135%),并可自动恢复						
	过电压	14.4 ~ 16.8V	28.8 ~ 33.6V	57.6 ~ 67.2V	14.4 ~ 16.8V	28.8 ~ 33.6V	57.6 ~ 67.2V	
	反极性	异常条件移除后通过MOSFET可自动恢复,无损坏						
	欠压锁定	48Vin (C - type): 电源 ON ≥ 33.6V, OFF ≤ 33V			110Vin (D - type): 电源 ON ≥ 67.2V, OFF ≤ 65V			
	工作温度	-40 ~ +70°C (请参考"降额曲线")						
环境	工作湿度	5 ~ 95% RH, 无冷凝						
	储存温度、湿度	-40 ~ +85°C, 5 ~ 95% RH, 无冷凝						
	温度系数	±0.03%/°C (0 ~ 55°C)						
	耐振动	组件: 10 ~ 500Hz, 5G 10分钟/周期, X, Y, Z 各60分钟; 安装: 符合 IEC61373						
	操作海拔高度	5000米						
安规和电磁兼容 (备注6)	安全规范	IEC 62368-1, UL 62368-1, EAC TP TC 004, AS/NZS 62368.1 认证通过; 设计参考 UL508						
	耐压	I/P-O/P: 4KVdc I/P-FG: 2.5KVdc O/P-FG: 2.5KVdc						
	绝缘阻抗	I/P-O/P, I/P-FG, O/P-FG: >100M Ohms / 500Vdc / 25°C / 70% RH						
	电磁兼容发射	Parameter	Standard			Test Level / Note		
		Conducted	BS EN/EN55032			Class B		
		Radiated	BS EN/EN55032			Class B		
		Voltage Flicker	BS EN/EN61000-3-3			-----		
		Harmonic Current	-----			-----		
	电磁兼容抗扰度	BS EN/EN55035, BS EN/EN61000-6-2(BS EN/EN50082-2)						
		Parameter	Standard			Test Level / Note		
		ESD	BS EN/EN61000-4-2			Level 3, 8KV air ; Level 3, 6KV contact; criteria A		
		Radiated	BS EN/EN61000-4-3			Level 3, 10V/m ; criteria A		
		EFT / Burst	BS EN/EN61000-4-4			Level 3, 2KV ; criteria A		
Surge		BS EN/EN61000-4-5			Level 3, 1KV/Line-Line ; Level 3, 2KV/Line-Line-FG ; criteria A			
Conducted		BS EN/EN61000-4-6			Level 3, 10V ; criteria A			
Magnetic Field		BS EN/EN61000-4-8			Level 4, 30A/m ; criteria A			
铁道标准	符合BS EN/EN45545-2 防火; 满足BS EN/EN50155 / IEC60571 包含 IEC61373 冲击和震动, BS EN/EN50121-3-2 电磁兼容							
其它	MTBF	1769.5K hrs min. Telcordia SR-332 (Bellcore); 214.5K hrs min. MIL-HDBK-217F (25°C)						
	尺寸	32*125.2*102mm (W*H*D)						
	包装	510g; 28pcs/15.3Kg/1.22CUFT						
备注	1. 如未特别说明, 所有规格参数均在输入为C:48Vdc, D:110Vdc, 额定负载、25°C 环境温度下进行量测。							
	2. 纹波和噪声测量方法: 使用一条12"双绞线, 同时终端要并联0.1uf和47uf的电容, 在20MHZ带宽下进行量测。							
	3. 精度: 包含设定误差、线性调整率和负载调整率。							
	4. 低输入电压情况下需降额输出, 具体请参考降额曲线图。							
	5. 最长3秒, 请参考峰值负载曲线。							
	6. 电源应视为一个独立的元件, 需结合终端设备进行电磁兼容相关确认。有关EMC测试操作指导, 请参阅“电源供应器EMI测试声明书”。(在明纬网站 http://www.meanwell.cc)							
	7. 当海拔高度超过2000米(6500英尺)时, 无风扇机型环境温度依每3.5°C/1000m比例下降, 有风扇机型环境温度依每5°C/1000m比例下降。 ※ 产品免责声明: 详情请参阅 http://www.meanwell.cc/serviceDisclaimer.aspx							

■ 方框图

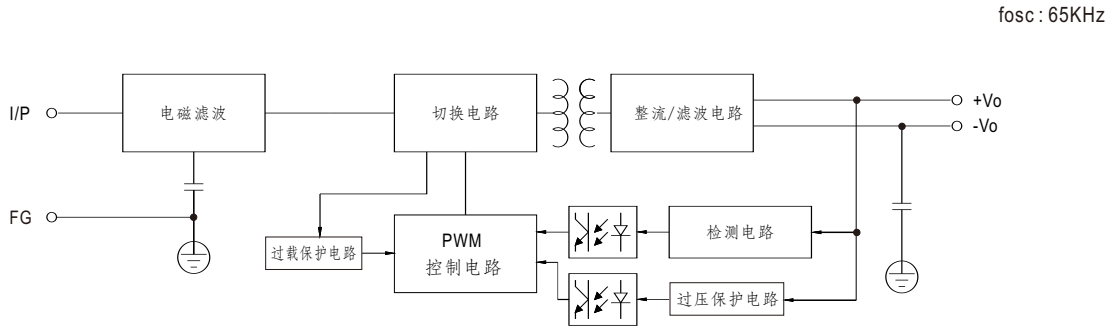

■ 降额曲线

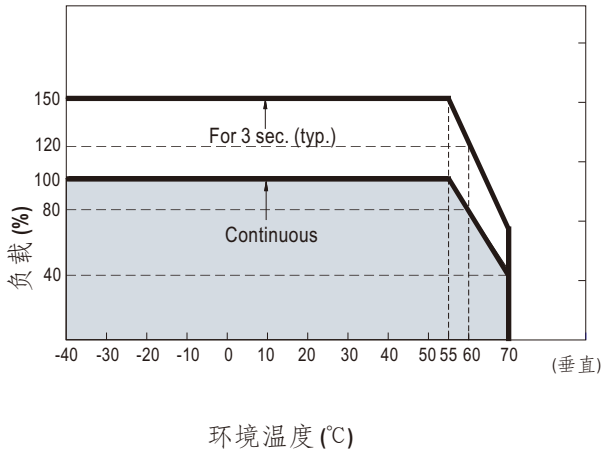

■ 降额VS输入电压曲线

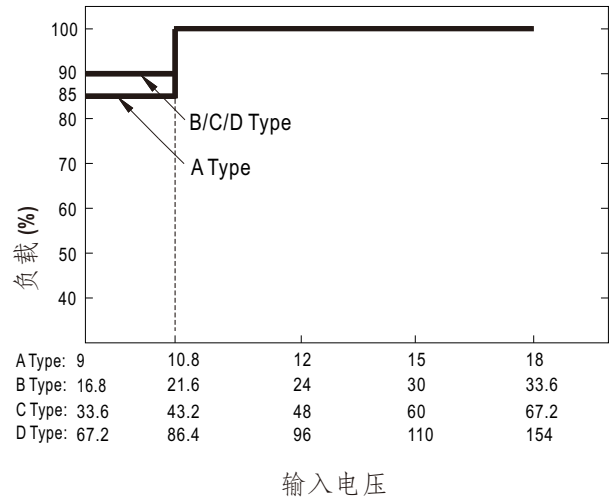

■ 峰值负载曲线

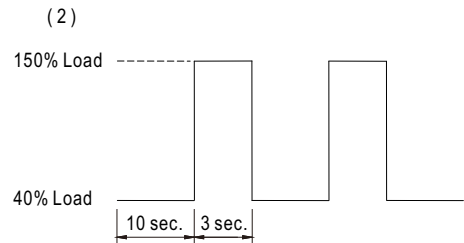
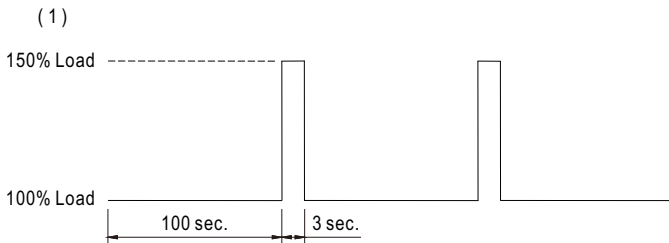

■ 输入端保险丝

在输入线路的正极有串联用于防止异常浪涌电流作用的保险丝，各机型保险丝规格如下表

型号	保险丝型号	厂商和规格
A	慢熔	Conquer MST, 10A, 250V *2
B	慢熔	Conquer MST, 8A, 250V *2
C	慢熔	Conquer MST, 8A, 250V *1
D	慢熔	Conquer MST, 4A, 250V *1

■ 输入欠压保护

如果输入电压低于 $V_{i\ min}$, 内部控制IC将关断且无电压输出，当输入电压达到 $V_{i\ min}$ 时自动恢复，请参考下列曲线

DDR-120A-24

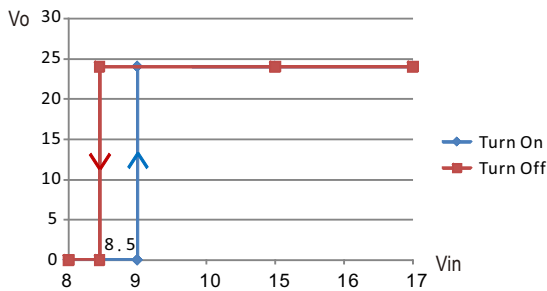

DDR-120B-24

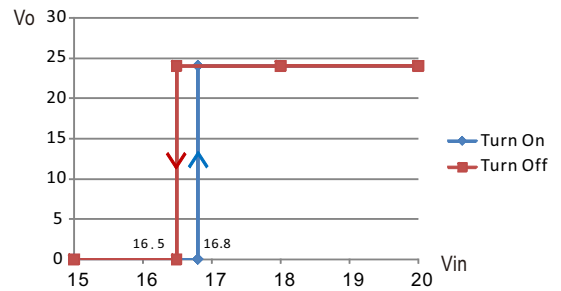

DDR-120C-24

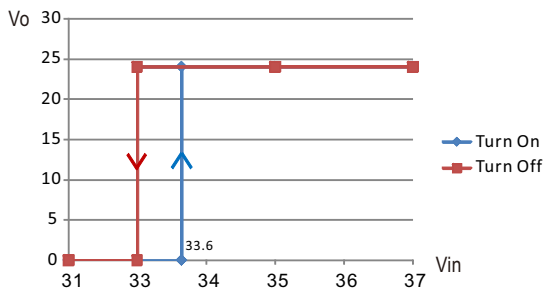

DDR-120D-24

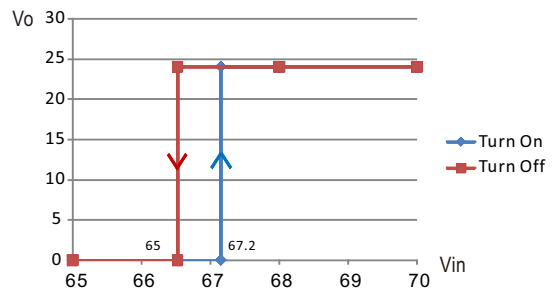

■ 输入反极性保护

输入电压的负极串联了一个场效应管，如果输入电压极性相反，场效应管将开路，电源无输出，达到保护设备作用。

■ 输入范围和瞬态能力

该系列产品具有宽范围的输入能力。在-30% / +40%的额定输入电压内(除了A型),它可以承受1秒电压。

■ 浪涌电流

在初始启动时，浪涌电流由电流限制电路抑制，启动完成后，由MOSFET将浪涌抑制线路短路，以降低功耗。

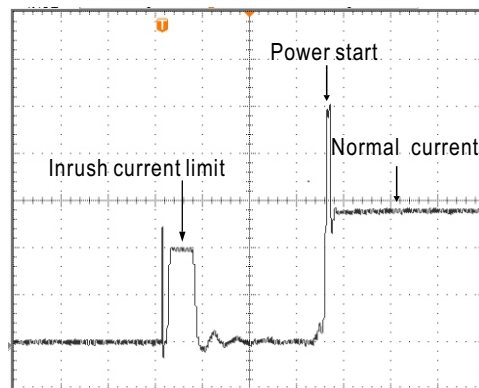

■ 保持时间

- EN50155:2007 版本 - 型号D可符合S2等级(10ms), 而型号A在满载条件下可符合S1等级(3ms), 为了满足S2等级要求, B型需降载至70%负载, C型需降载至60%负载请参考下表曲线

DDR-120A-12

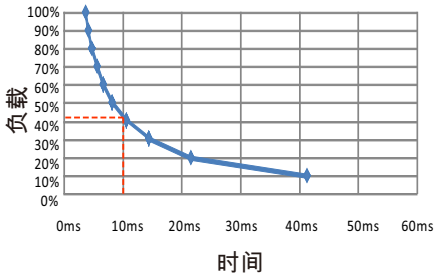

DDR-120A-24

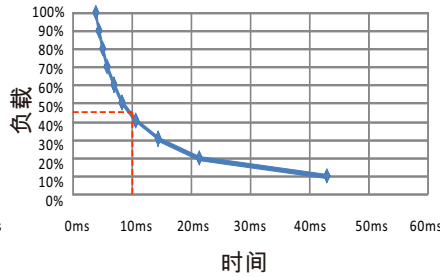

DDR-120A-48

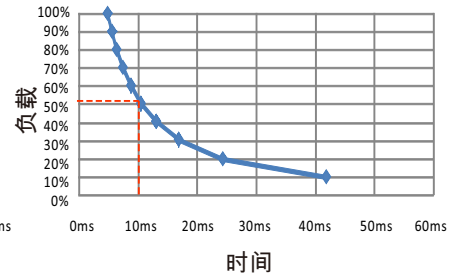

DDR-120B-12

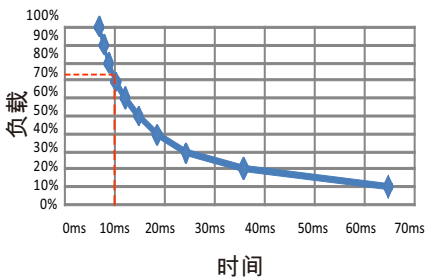

DDR-120B-24

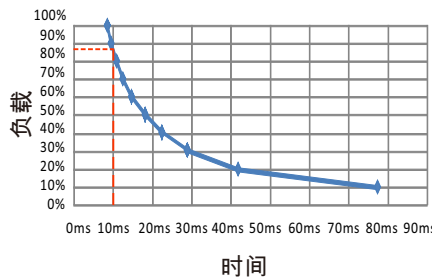

DDR-120B-48

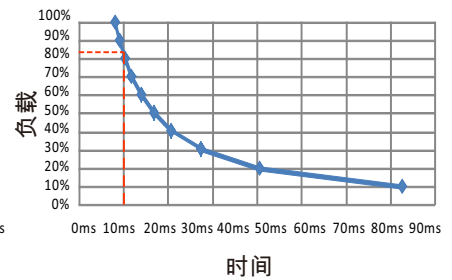

DDR-120C-12

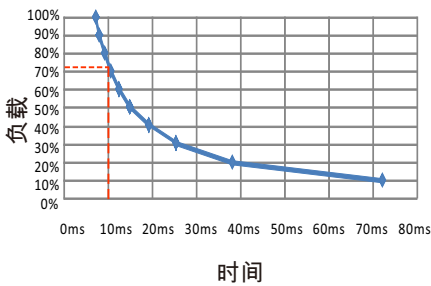

DDR-120C-24

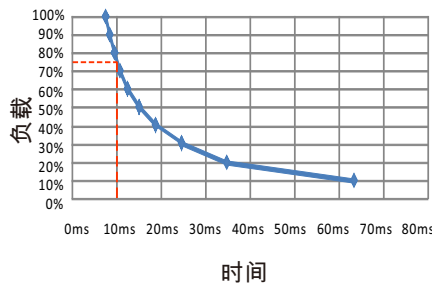

DDR-120C-48

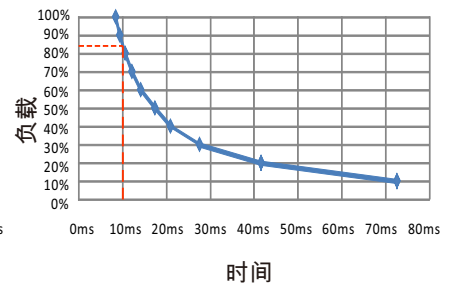

DDR-120D-12

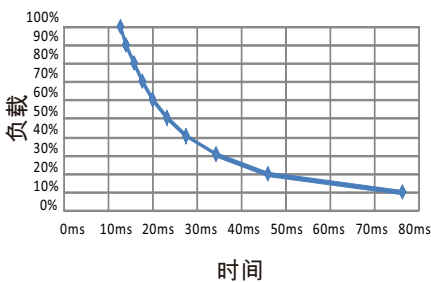

DDR-120D-24

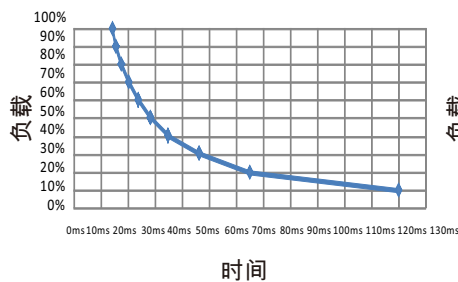

DDR-120D-48

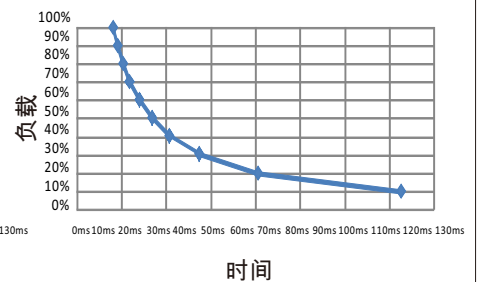

- EN50155:2017 版本 - 符合S1等级(6ms)

■ 效率vs负载& Vin曲线

各机型效率vs负载& Vin曲线如下表所示

DDR-120A-12

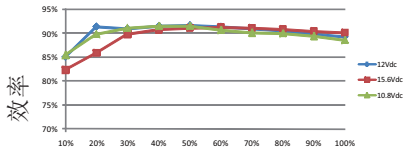

负载

DDR-120A-24

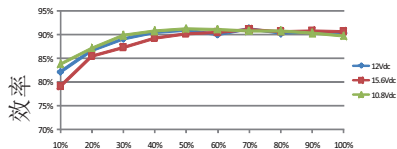

负载

DDR-12A-48

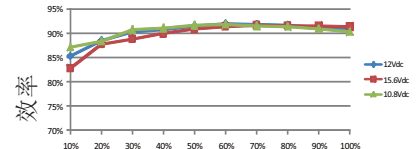

负载

DDR-120B-12

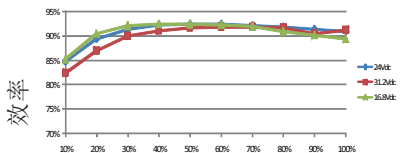

负载

DDR-120B-24

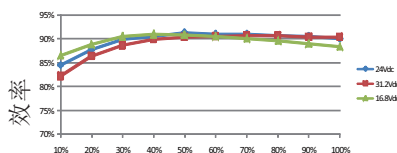

负载

DDR-120B-48

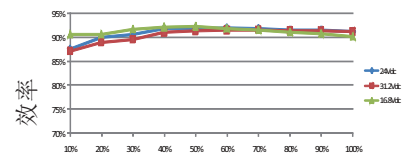

负载

DDR-120C-12

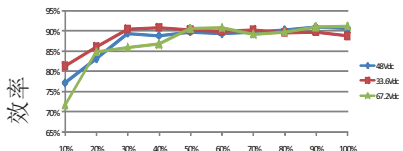

负载

DDR-120C-24

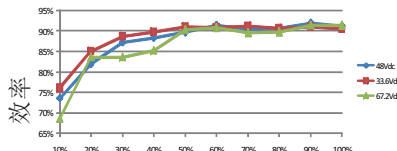

负载

DDR-120C-48

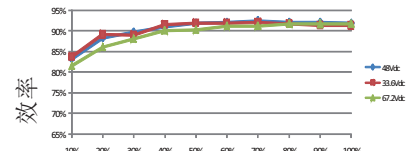

负载

DDR-120D-12

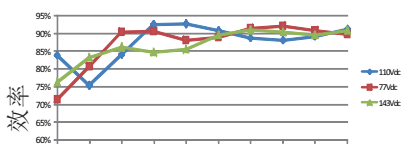

负载

DDR-120D-24

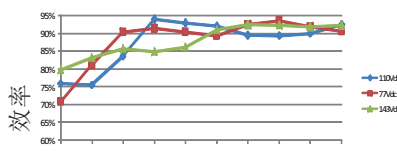

负载

DDR-120D-48

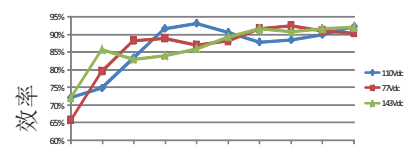

负载

■ 环境条件的抗扰度

测试方法	标准	测试条件	状态
Cooling Test	EN 50155 section 12.2.3 (Column 2, Class TX) EN 60068-2-1	Temperature: -40°C Dwell Time: 2 hrs/cycle	No damage
Dry Heat Test	EN 50155 section 12.2.4 (Column 2, Class TX) EN 50155 section 12.2.4 (Column 3, Class TX & Column 4, Class TX) EN 60068-2-2	Temperature: 70°C / 85°C Duration: 6 hrs / 10min	PASS
Damp Heat Test, Cyclic	EN 50155 section 12.2.5 EN 60068-2-30	Temperature: 25°C~55°C Humidity: 90%~100% RH Duration: 48 hrs	PASS
Vibration Test	EN 50155 section 12.2.11 EN 61373	Temperature: 19°C Humidity: 65% Duration: 10 mins	PASS
Increased Vibration Test	EN 50155 section 12.2.11 EN 61373	Temperature: 19°C Humidity: 65% Duration: 5 hrs	PASS
Shock Test	EN 50155 section 12.2.11 EN 61373	Temperature: 21 ± 3°C Humidity: 65 ± 5% Duration: 30ms*18	PASS
Low Temperature Storage Test	EN 50155 section 12.2.3 (Column 2, Class TX) EN 60068-2-1	Temperature: -40°C Dwell Time: 16 hrs	PASS
Salt Mist Test	EN 50155 section 12.2.10 (Class ST4)	Temperature: 35°C ± 2°C Duration: 96 hrs	PASS

■ EN45545-2防火测试条件

测试项目		危险等级			
	Items	Standard	HL1	HL2	HL3
R22	Oxygen index test	EN 45545-2:2013 EN ISO 4589-2:1996	PASS	PASS	PASS
	Smoke density test	EN 45545-2:2013 EN ISO 5659-2:2006	PASS	PASS	PASS
	Smoke toxicity test	EN 45545-2:2013 NF X70-100:2006	PASS	PASS	PASS
R24	Oxygen index test	EN 45545-2:2013 EN ISO 4589-2:1996	PASS	PASS	PASS
R25	Glow-wire test	EN 45545-2:2013 EN 60695-2-11:2000	PASS	PASS	PASS
R26	Vertical flame test	EN 45545-2:2013 EN 60695-11:2003	PASS	PASS	PASS

■ 机构尺寸

Case No. Unit:mm

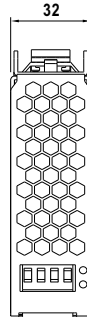

顶视图

端子Pin脚编号(TB2)

Pin脚编号	功能
1,2	直流输出 -Vo
3,4	直流输出 +Vo

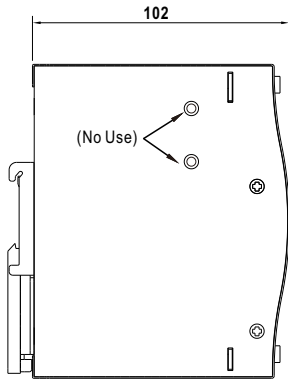

左视图

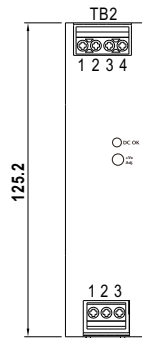

主视图

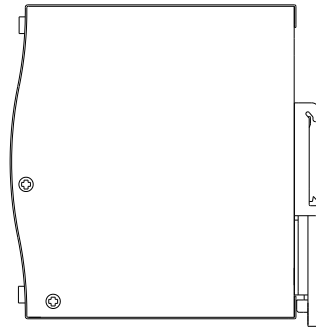

右视图

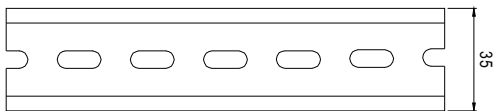

安装轨道:TS35/7.5 或 TS35/15

端子Pin脚编号(TB1)

Pin脚编号	功能
1	FG Ⓟ
2	直流输入 -Vin
3	直流输入 +Vin

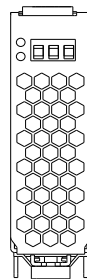

底视图

■ 安装手册

请查阅: <http://www.meanwell.com/manual.html>